

CLT by Stora Enso

Technical brochure





Stora Enso

The renewable materials company

Part of the bioeconomy, Stora Enso is a leading provider of renewable solutions in packaging, biomaterials, wooden constructions and paper on global markets.

We believe that everything that is made from fossil-based materials today can be made from a tree tomorrow. Our materials are renewable, reusable and recyclable, and form the building blocks for a range of innovative solutions that can help replace products based on fossil fuels and other non-renewable materials.

With carbon captured in the wood, the products offer a truly sustainable means of combating climate change.

Stora Enso products are entirely made from renewable wood, sourced from sustainably managed forests. The wood supply chains to Stora Enso's Wood Products units are covered by a third-party certified wood traceability system.

Contents

1. CLT – Cross Laminated Timber	4
Key data	4
Standard designs	5
Panel design	6
Surface qualities	7
Quality descriptions	8
2. Structure	10
3. Building physics	12
Thermal insulation	12
Air-tightness	14
Moisture	16
Soundproofing with CLT	18
CLT and fire protection	21
4. Structural analysis	24
General information	24
Calculating and dimensioning CLT	25
Dimensioning CLT with Stora Enso’s CLT design software	26
Preliminary design tables	26
5. Project management	28

This brochure is a summarised version of the technical CLT folder. Please refer to the folder for more information about the references to sources.

See also: [storaenso.com/woodproducts/clt](https://www.storaenso.com/woodproducts/clt)
Stora Enso Wood Products GmbH accepts no liability for the completeness or accuracy of the information contained.

1. CLT

Cross Laminated Timber

Key data

Application	Structural elements for walls, floors and roofs
Maximum element dimensions	Length: 16 m / Width: 3.45 m / Thickness: 0.35 m
Invoiced widths	2.25 m / 2.45 m / 2.75 m / 2.95 m / 3.25 m* / 3.45 m* *Please contact your local sales representative for more information regarding the larger dimensions
Panel lay-up	3, 5, 7 or more layers depending on structural design requirements
Wood species	Spruce (silver fir and larch on request)
Strength class	C24 according to EN 338, maximum 10% C16 permitted (other strength class compare with ETA 14/0349)
Moisture content	12% +/-2% on delivery
Adhesive	Formaldehyde-free PUR adhesive for finger jointing and surface bonding, approved for load-bearing and non-load-bearing components indoors and outdoors according to EN 15425; Formaldehyde-free EPI adhesive for narrow side bonding
Surface quality	Non-visual quality (NVI), Industrial visual quality (IVI) and Visual quality (VI); the surfaces are always sanded on both faces
Weight	For determining transport weight: approx. 470 kg/m ³
Fire rating	In accordance with Commission Decision 2003/43/EC: <ul style="list-style-type: none">• Timber components (apart from floors) ● Euroclass D-s2, d0• Floors ● Euroclass Dfl-s1
Thermal conductivity	0.12 W/(mK)

Panel design

CLT solid wood panels are made up of at least three layers of bonded single-layer panels arranged at right angles to one another. From five layers, CLT can also include middle layers (transverse layers) without narrow side bonding. It can currently be produced with dimensions of up to 16.0 × 3.45 m.

Example:
Design of a 5-layer
CLT solid-wood panel

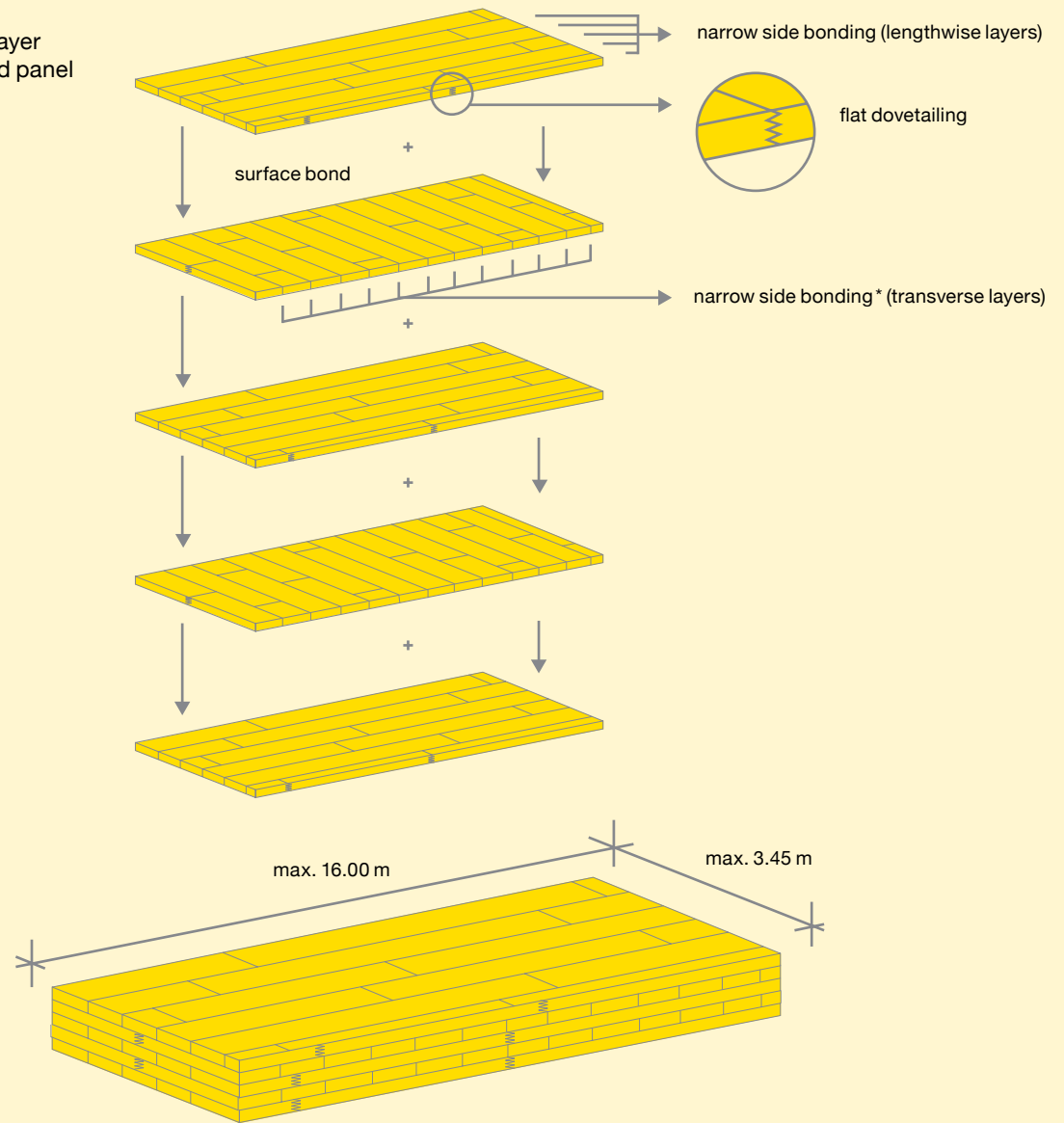

* From five layers, middle layers (transverse layers) can also be processed without narrow side bonding.

Standard designs

C panels

The grain direction of the cover layers is always parallel to the production widths.

Thickness [mm]	Panel type [–]	Layers [–]	Panel design [mm]						
			C***	L	C***	L	C***	L	C***
60	C3s	3	20	20	20				
80	C3s	3	20	40	20				
90	C3s	3	30	30	30				
100	C3s	3	30	40	30				
120	C3s	3	40	40	40				
100	C5s	5	20	20	20	20	20		
120	C5s	5	30	20	20	20	30		
140	C5s	5	40	20	20	20	40		

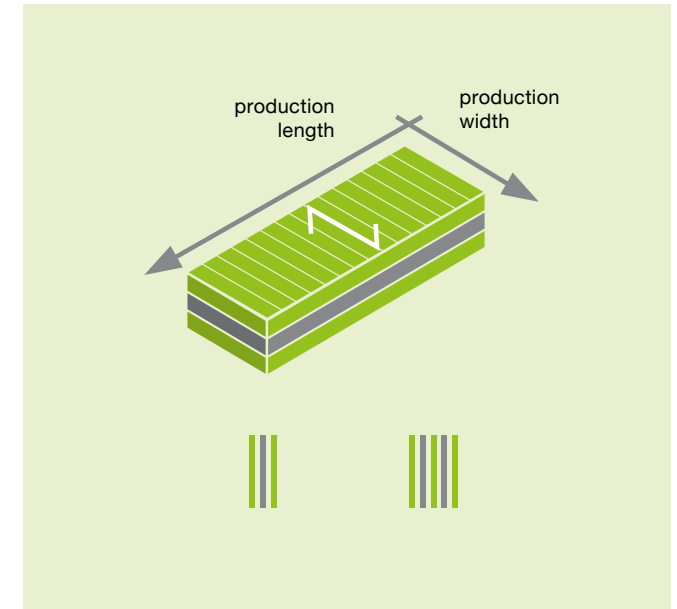

* cover layers consisting of two lengthwise layers

** cover layers and inner layer consisting of two lengthwise layers

*** with C panels, the sanding direction is at right angles to the grain

Production widths: 225 cm, 245 cm, 275 cm, 295 cm, 325 cm, 345 cm

Production lengths: from minimum production length of 8.00 m per charged width up to max. 16.00 m (in 10 cm increments)

L panels

The grain direction of the cover layers is always at right angles to the production widths.

Thickness [mm]	Panel type [-]	Layers [-]	Panel design [mm]						
			L	C	L	C	L	C	L
60	L3s	3	20	20	20				
80	L3s	3	20	40	20				
90	L3s	3	30	30	30				
100	L3s	3	30	40	30				
120	L3s	3	40	40	40				
100	L5s	5	20	20	20	20	20		
120	L5s	5	30	20	20	20	30		
140	L5s	5	40	20	20	20	40		
160	L5s	5	40	20	40	20	40		
180	L5s	5	40	30	40	30	40		
200	L5s	5	40	40	40	40	40		
160	L5s-2*	5	60	40	60				
180	L7s	7	30	20	30	20	30	20	30
200	L7s	7	20	40	20	40	20	40	20
240	L7s	7	30	40	30	40	30	40	30
220	L7s-2*	7	60	30	40	30	60		
240	L7s-2*	7	80	20	40	20	80		
260	L7s-2*	7	80	30	40	30	80		
280	L7s-2*	7	80	40	40	40	80		
300	L8s-2**	8	80	30	80	30	80		

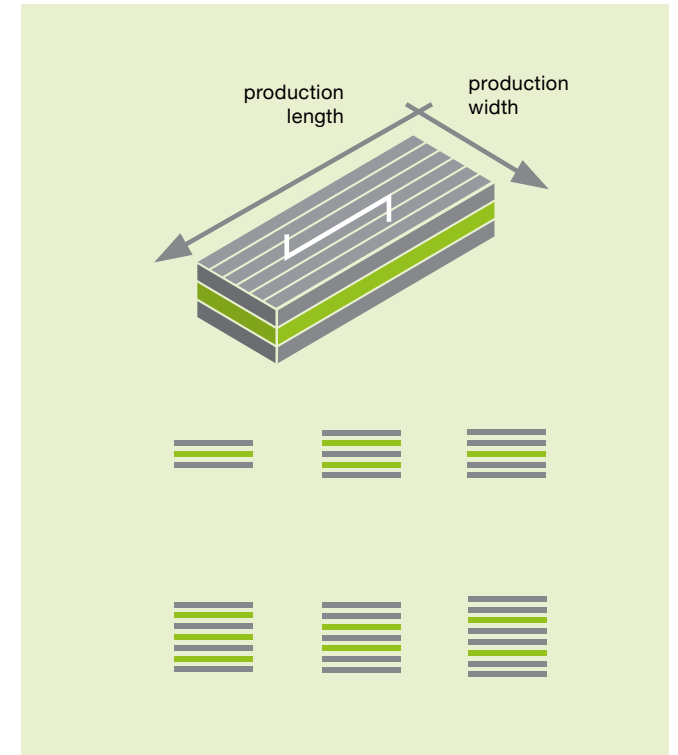

Surface qualities

CLT surface quality Surface quality appearance with respect to product characteristics			
Characteristics	VI	IVI	NVI
Surface finish	sanded	sanded	≤ 10 % of the surface may not be sanded
Timber species	one single species	one single species	addition of other timber species allowed
Moisture content	≤ 11 %	≤ 15 %	≤ 15 %
Narrow side bonding	occasional open joints permitted ≤ 1 mm	occasional open joints permitted ≤ 2 mm	occasional open joints permitted ≤ 3 mm
Discolouration	slight discolouration permitted ≤ 1 %	slight discolouration permitted ≤ 3 %	permitted
Knots — sound	permitted	permitted	permitted
Knots — black	occasional occurrences permitted ≤ 15 mm Ø	permitted ≤ 30 mm Ø	permitted
Loose knots, knot holes	occasional occurrences permitted ≤ 10 mm Ø	permitted ≤ 20 mm Ø	permitted
Resin pockets	occasional occurrences permitted ≤ 5 x 50 mm	occasional occurrences permitted ≤ 10 x 90 mm	permitted
Bark ingrowths	occasional occurrences permitted	occasional occurrences permitted	permitted
Rough edges / wane	not permitted	not permitted	permitted ≤ 20 x 500 mm
Hartwood pith	occasional occurrences permitted ≤ 400 mm length	permitted	permitted
Cracks and gaps between lamella (at reference moisture of 11%)	occasional occurrences permitted ≤ 1 mm	occasional occurrences permitted ≤ 2 mm	occasional occurrences permitted ≤ 3 mm
Boreholes from inactive insect attack	not permitted	not permitted	occasional occurrences permitted
Quality of surface finish	occasional small defects permitted	occasional defects permitted	occasional defects permitted
Quality of end grain	occasional small defects permitted	occasional defects permitted	occasional defects permitted
Surface retreatment (plugs, fillers, strips, etc.)	permitted	permitted	permitted
Chamfer on L-panels in grain direction	yes	yes	no
Sanding scratches / sanding directions	Sanding marks on L-panels run in grain direction, on C-panels across grain direction.		
CNC cutting on visual quality (VI) surface	CNC cutting on visual quality (VI) surface will be carried out exclusively with milling and cutting tools that cause no soiling through chain oil.		
Crack formations	Crack formations and open joints caused by swelling and shrinking due to later equilibrium moisture in normal use status is wood specific and cannot be prevented.		
Validity	The quality requirements to the surfaces listed above are valid: • on delivery • for top and bottom surfaces only All end grains / edges are to be considered as NVI quality.		



Quality descriptions

Stora Enso offers three different CLT surface qualities

NVI	Non-visual quality
IVI	Industrial visual quality

CLT qualities available from Stora Enso are based on three different surface qualities

Quality description	NVI	VI	BVI	INV	IBI	IVI
Cover layer	NVI	VI	VI	IVI	IVI	VI
Middle layer	NVI	NVI	NVI	NVI	NVI	NVI

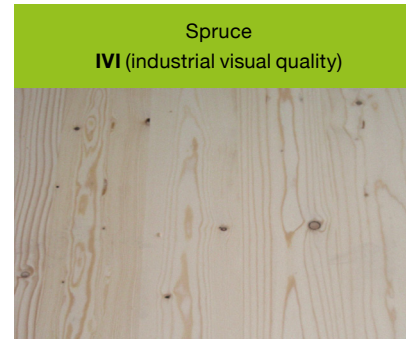

2. Structure



Examples of design details and component designs

CLT elements have a wide range of applications. For example, when used on external, internal and partition walls, due to their structure which consists of bonded boards arranged at right angles to one another, they assume both a load-bearing and a bracing function in the building.

The high level of prefabrication and related short assembly times are a major advantage, especially when CLT panels are used as roof elements, as buildings can be rendered rain-proof in short time scales. Thanks to CLT, roofs and ceilings can be economically designed with standard span lengths, and building requirements can be fully satisfied. With the right choice of structural components this can be easily achieved and, at the same time, CLT can be combined with virtually any type of construction material.

Ceiling
Ceiling joint (butt board)

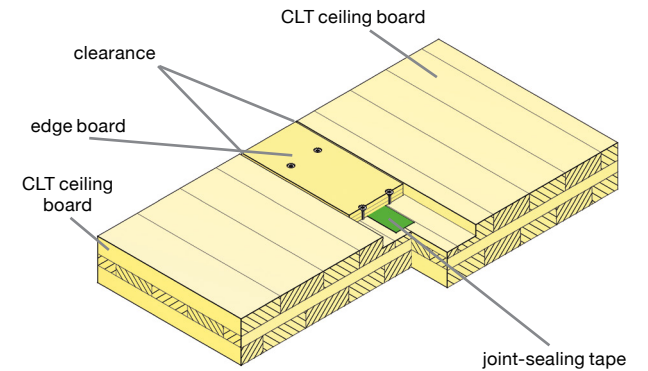

Ceiling
Ceiling joint (stepped rebate)

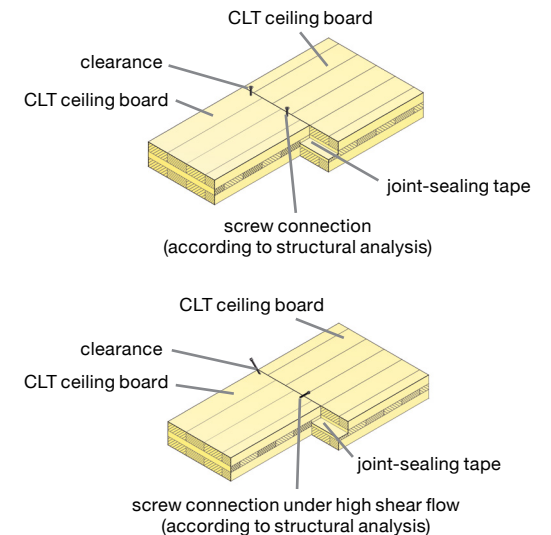

**External wall
Insulation with mineral wool**

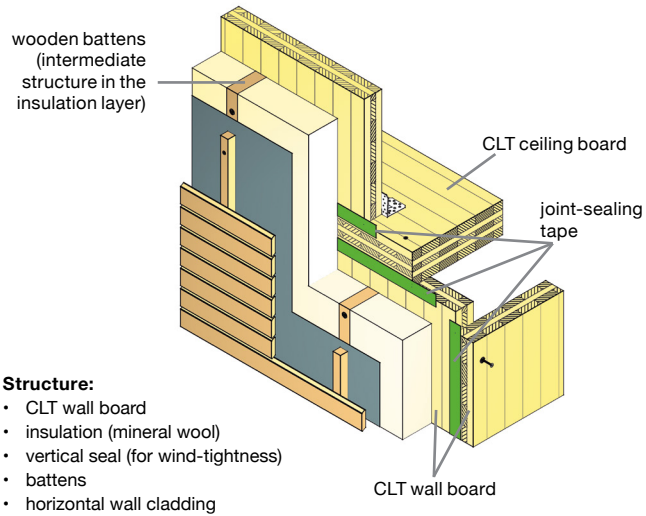

- Structure:**
- CLT wall board
 - insulation (mineral wool)
 - vertical seal (for wind-tightness)
 - battens
 - horizontal wall cladding

**Internal wall
Facing panel (spring clips)**

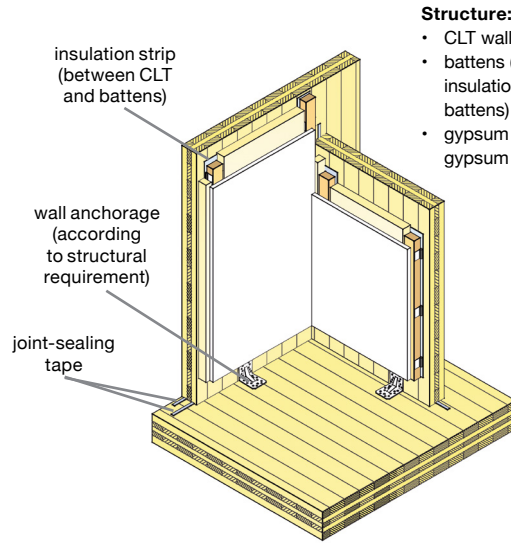

- Structure:**
- CLT wall board
 - battens (on spring clips), insulation (between battens)
 - gypsum cardboard or gypsum fibreboard

**Floor structure
Wet screed**

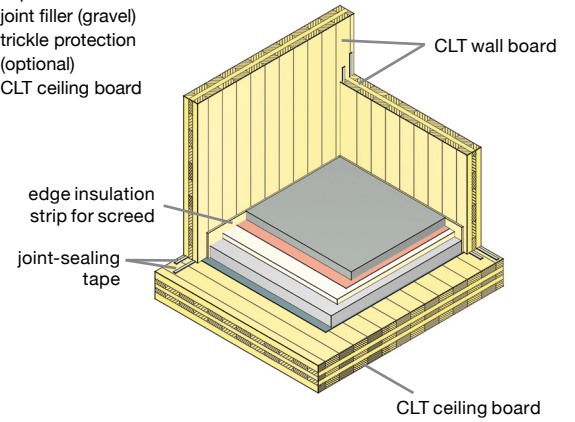

- Structure:**
- screed
 - partition layer
 - impact sound insulation
 - joint filler (gravel)
 - trickle protection (optional)
 - CLT ceiling board

**Party wall
System with double-wall CLT arrangement**

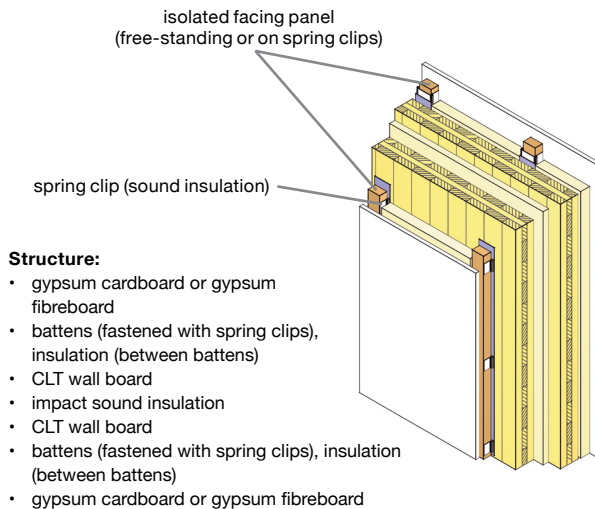

- Structure:**
- gypsum cardboard or gypsum fibreboard
 - battens (fastened with spring clips), insulation (between battens)
 - CLT wall board
 - impact sound insulation
 - CLT wall board
 - battens (fastened with spring clips), insulation (between battens)
 - gypsum cardboard or gypsum fibreboard

**Window connection
Installation with expanding foam tape**

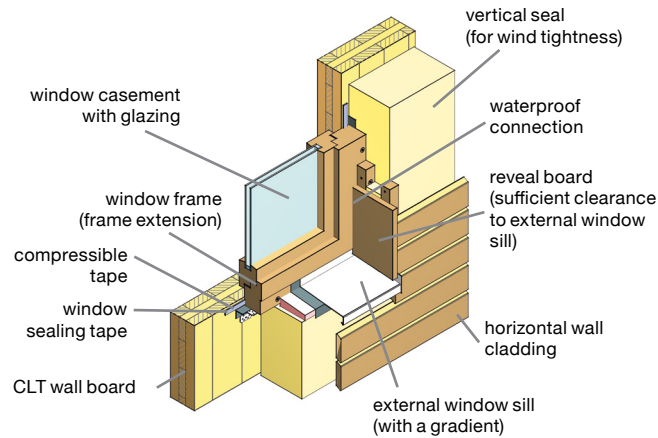

**Multi-storey residential buildings
Ground floor wall – ceiling – top floor wall**

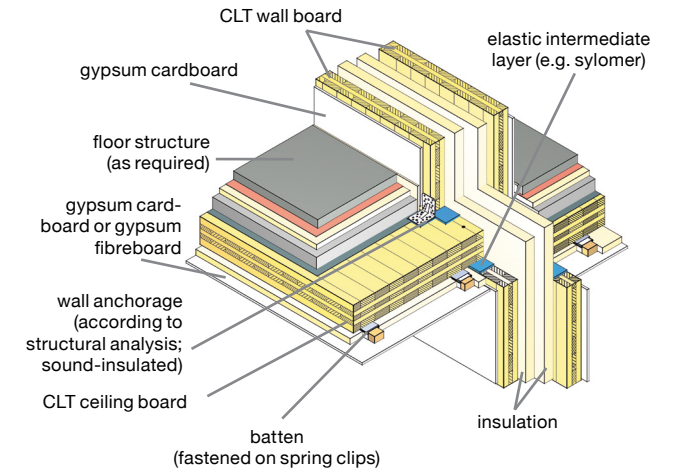

3. Building physics

Thermal insulation

Introduction

The notion “thermal insulation of buildings” covers all measures implemented to reduce heating requirements¹ during the winter and cooling requirements² in the summer. Thus the aim of thermal insulation is to keep energy consumption as low as possible while taking into account the functionality of different building components and their insulating properties, and at the same time ensuring comfort and creating a pleasant indoor atmosphere.

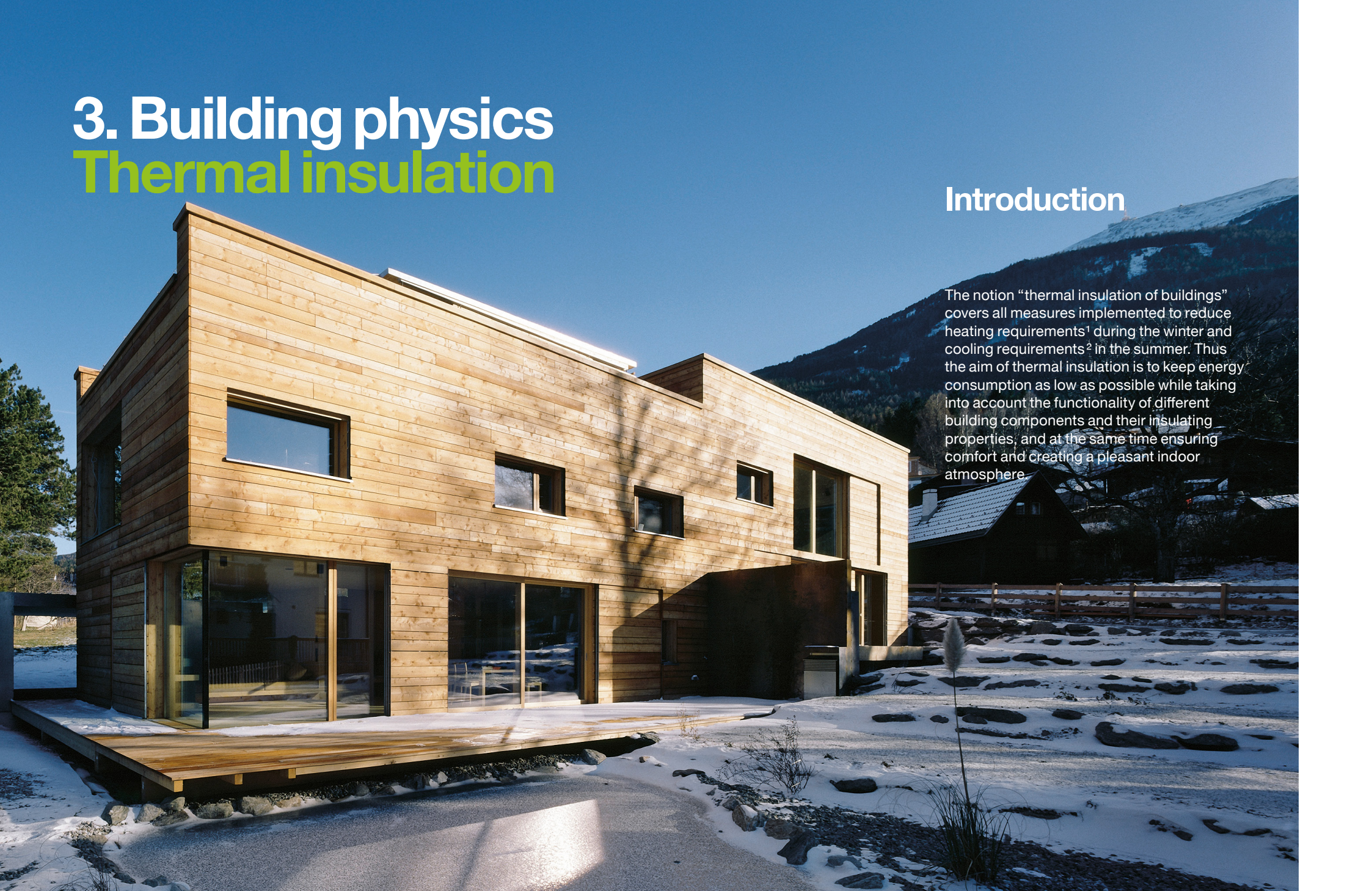

Thermal insulation with CLT

The thermal performance of a component is determined by its U-value or rate of transfer of heat (also known as thermal transmittance). The location in the building and the structure, thermal conductivity and dimensions of the individual materials contained must be known in order to calculate this value. The thermal conductivity of wood is essentially determined by its bulk density and wood moisture content and can be calculated for CLT with a value of $\lambda = 0.12 \text{ W/mK}$.

The following illustration shows a graph on which the U-values of insulated CLT panels with a thickness of 100 mm are plotted depending on the thickness of the insulation material (thermal conductivity group WLG 040).

U-value of CLT 100 mm

With a variable insulation thickness

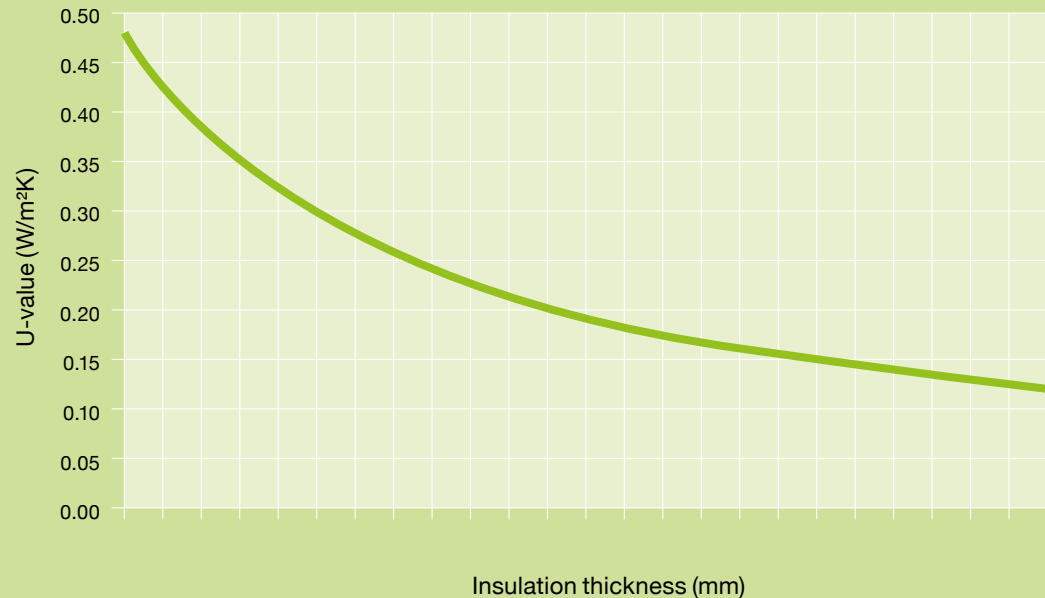

Thermal insulation factors and principles in the winter

- avoidance of exposed locations
- preference given to a compact construction method
- optimum building orientation particularly in terms of the windows
- sufficiently insulated building envelope
- avoidance of thermal bridges
- sufficient air-tightness of the building envelope
- energy transmission level and shading of windows
- total surface area, orientation and angle of inclination of windows
- thermal insulating properties of opaque exterior components
- internal heat loads (people, electrical devices, etc.)
- floor plan or spatial geometry
- ventilation of living areas
- heat-storage capacity of constructive elements in living areas

- 1) Quantity of heat which must be supplied to the building during the course of one year in order to keep a minimum room temperature.
- 2) Quantity of heat which must be evacuated from the building during the course of one year in order not to exceed a maximum room temperature.



Air-tightness

An air- and wind-tight building envelope is an essential requirement for an energy-efficient building. An air-tight layer on the inside of the building prevents the penetration of damp air and subsequently the formation of condensation in components. This impacts the heat and humidity balance, and therefore the energy balance of buildings, and is critical to the quality and durability of the building's structure.

From three layers, CLT is air-tight

Inadequate air-tightness can mean that air flows through the structure from inside to outside.

The wind-tightness of a building envelope is just as relevant as its air-tightness. The wind-tight layer on the outside of the building prevents outside air from penetrating the structural components. The thermal insulation layer is therefore protected, and the components' insulating properties are not impaired. In general, wind-tightness is not ensured by the CLT element but rather by plaster in the case of a plastered façade or by a permeable thermo-membrane behind the ventilation level in the case of wooden façades.

The air-tightness of Stora Enso CLT has been tested by the Holzforschung Austria.

Outcome:

“The element joints and the CLT element itself exhibit a high level of air-tightness. The volumetric flow rates through the two joint variants and through the undisturbed surface lay outside the measurable range as a result of the high level of impermeability.”

This air-tightness test on CLT was carried out on the basis of ÖNORM EN 12114:2000 and included the element itself, a stepped rebate and an element joint with a jointing board.



CLT also remains air-tight throughout its service life

Throughout its service life, CLT is exposed to different moisture conditions. It is produced with a relative timber moisture content of $12\% \pm 2\%$ depending on the surface quality.

During the construction phase, it absorbs building moisture, for instance, from joint filler, screed or plaster, thus increasing the timber moisture content. The service life is also characterised by seasonal fluctuations in timber moisture content. Domestic ventilation can also dry out CLT during the winter months. These moisture content fluctuations of CLT are connected to changes in the shape of the wood (swelling or shrinkage), which in extreme cases can manifest themselves through cracks

in the surface (too dry) or through an undulating surface (too damp).

Tests carried out at the Technical University of Graz's laboratory for building physics demonstrated that CLT remains air-tight even in the long-term. The usual fluctuations in timber moisture content were simulated in the climatic cabinet, and CLT was exposed to four different moisture conditions to test its air permeability.

The test was performed on a 3-layer, 100 mm-thick CLT element in non-visual quality (CLT 100 3s NVI) with dimensions of $2\text{ m} \times 2\text{ m}$, which was vertically joined once with a stepped rebate and once with a butt joint.



Moisture

The aim of moisture protection is to limit the various effects of moisture on building constructions to such an extent that damage — for example, reduction of thermal performance, loss of strength of building materials, mould and rot — is prevented. The various effects of moisture include, in particular, condensation, atmospheric moisture and rising damp. In addition, during the construction phase, increased moisture content of building materials can occur due to the absorption of building moisture from screed or plaster for example.

Hygrothermal principles

Where timber, and therefore CLT, is concerned, we basically differentiate between three moisture transport mechanisms:

- vapour diffusion
- sorption
- capillary transport

In addition to these basic moisture transport mechanisms, when considering the moisture protection of wood, any likely convective processes should also be taken into account. Due to its structure, which consists of layers of timber bonded at right angles to each other across the full surface, CLT in itself prevents the appearance of any convection phenomena. However, connections, fixtures and installations should be checked for leaks.

CLT's vapour diffusion behaviour

The proportion of glue in CLT varies according to the lamella structure, however it remains less than 1%. Nevertheless, the adhesive joints of the surface bonding have a different water vapour diffusion resistance factor to that of the surrounding wood lamellas and must be taken into account when determining the s_d value.

It should also be borne in mind that, throughout its service life, CLT is exposed to fluctuating moisture conditions due to residual moisture from the construction of the building, moisture during the heating season and humid air in the summer. These fluctuating moisture conditions can result in a timber moisture content varying between 8% and 14% which affects CLT's vapour diffusion behaviour.

Tests to establish the water vapour diffusion resistance factor (μ) of adhesive joints in CLT elements delivered the following results:

- The water vapour diffusion resistance factor depends on the level of humidity, and in damp test conditions, a clearly reduced μ of the bonded joints was observed.
- In a dry climate (23 °C and 26.5% mean RH), the CLT adhesive joint has the same transmission-equivalent air film thickness as a spruce lamella with a thickness of 6 mm \pm 4 mm. In a humid climate (23 °C and 71.5% mean RH), the adhesive joint has the same transmission-equivalent air film thickness as a spruce lamella with a thickness of 13 mm \pm 6 mm.
- Thus, a 3-layer CLT element (with two flat adhesive joints) has, on average, a transmission-equivalent air film thickness corresponding to a spruce lamella of the same thickness plus 12 mm in a dry climate and plus 26 mm in a humid climate.

In addition, during the course of a master's thesis, CLT test bodies were tested at the Thünen-Institut für Holzforschung in Hamburg and their moisture-dependent water vapour diffusion resistance factor was determined:

- The water vapour diffusion resistance factor of CLT increases at a roughly linear rate in relation to the number of adhesive joints (which increases according to the thickness of the CLT element). This result enables an average number of adhesive joints to be defined per cm of CLT thickness.
- By taking this average number of adhesive joints into account, the following water vapour diffusion resistance factors were determined for varying levels of wood moisture content:
 - ▶ 11.3% wood moisture content $\ominus \mu = 52 \pm 10$
 - ▶ 14.7% wood moisture content $\ominus \mu = 33 \pm 7$
 - ▶ 8.0% wood moisture content $\ominus \mu = \sim 105$ (obtained by interpolation)

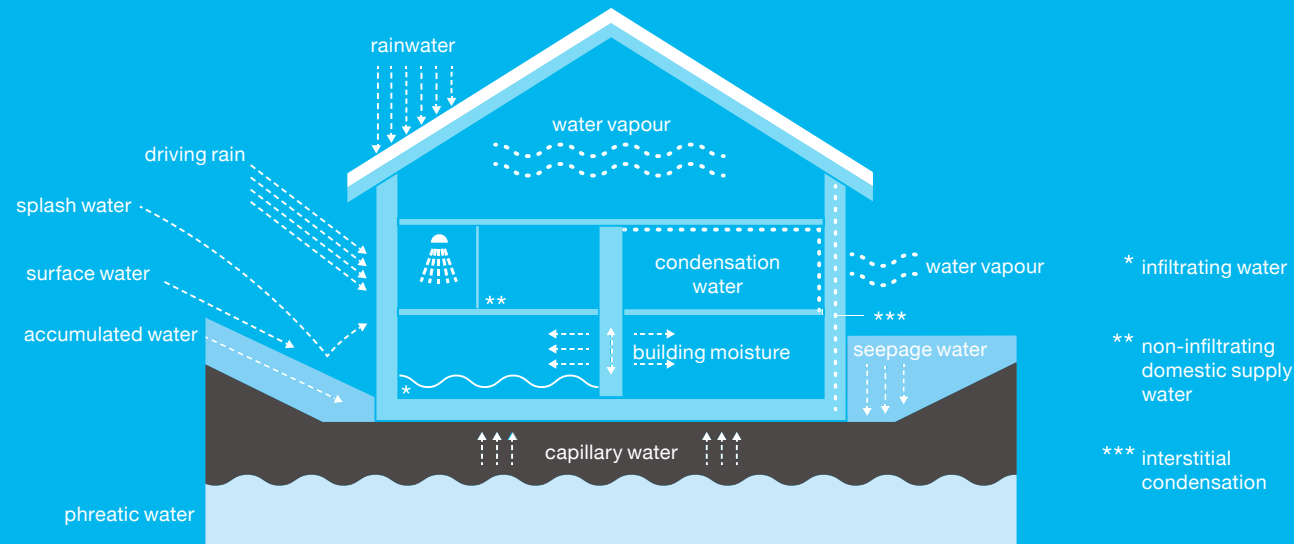

CLT as a moisture variable vapour barrier

With 3 layers and more, CLT elements are “air-tight” but not vapour-proof. CLT is permeable and the adhesive bonds form vapour barriers for the insulation plane.

Thus, CLT reacts like a variable vapour barrier. During the heating season, when the relative humidity inside the building decreases, CLT loses its ability to transport moisture and becomes more diffusion-resistant. On the other hand, during the summer, when the level of humidity inside the building increases again, CLT becomes more open to diffusion. This natural property of wood is an advantage in the construction industry as it enables structures to be designed and built which remain sustainably operational and take into account the building physics construction principle of permeability needing to increase from inside to outside.

Thus, CLT also helps to regulate the ambient air. When there is higher ambient humidity, CLT absorbs the moisture and releases it again when the level of humidity decreases.

Assessing moisture protection

In the past, the moisture protection of building components was mainly assessed according to the Glaser method. However, this method only allows for rough assessments of the moisture properties of structural components. The development of hygrothermal simulation programs heralded new possibilities for calculating, in a realistic and detailed way, the hygrothermal transport and storage processes in components under real climatic conditions.

However, this realistic calculation increases the complexity and number of building material characteristic values required. These necessary material specifications were determined for CLT at the University of Hamburg for the WUFI simulation program (WUFI: “transient heat and moisture”) developed by the Fraunhofer-Institut für Bauphysik (IBP). Furthermore, an experiment was carried out for the first time to validate the hygrothermal simulation of a cross-laminated timber element. It established that a good correlation could be achieved between experimental field tests and numerical simulations.

Stora Enso CLT was positively assessed for plausibility by the Fraunhofer-Institut and entered into the WUFI database of materials. This enables us to offer our customers and project managers a valuable new planning tool for CLT structures. This extremely promising tool will prove to be indispensable in cases of high moisture loads inside buildings or when using timber components in regions with extreme climatic conditions.

Soundproofing with CLT

Providing adequate protection from noise disturbance is an important factor for ensuring a sense of well-being in buildings. Therefore, sound insulation should be a top priority during the planning stage.

Sound is defined as mechanical kinetic energy which is transmitted through elastic media by pressure and density fluctuations. Thus, sound is the audible vibration of gases fluids and solids. After identifying the source of noise to which a component is exposed, acoustic design distinguishes between airborne and structure-borne sound.

Airborne sound: air sound waves cause components to vibrate, and these vibrations are transmitted to adjacent rooms in the building. Sources of airborne sound include traffic, voices or music.

Structure-borne sound — the sound of walking, banging, scraping furniture, etc. — is transmitted to components and radiated as airborne sound into adjacent rooms. **Impact sound** is particularly relevant to the acoustic design.

Determining the quality of sound insulation

To determine the quality of sound insulation, a building component is placed in a source room (in the test facility or a building) where it is exposed to a source of noise. The incoming sound is then measured in a receiving room.

As noise levels are mostly measured in third-octave bands, measured curves are used to determine single values in order to improve the comparison of data. These single values are calculated on the basis of weighting curves in accordance with

EN ISO 717 (part 1 for airborne sound and part 2 for impact sound). These weighted curves are derived from the “curves of equal volume” (the human ear perceives sound with the same volume level but different frequencies) and thus take into account the human ear’s frequency-related perception of sound levels. A wide frequency range (of 50 Hz to 5,000 Hz) is measured, however only the range between 100 Hz and 3,150 Hz is taken into account to calculate the single values.

Normative sound insulation requirements ensure that persons with normal sensitivities are provided with sufficient protection against noise from outside the building, from other parts of the same building and from adjacent buildings. The role of acoustic design is to reduce disturbing noise in the building to a defined degree.

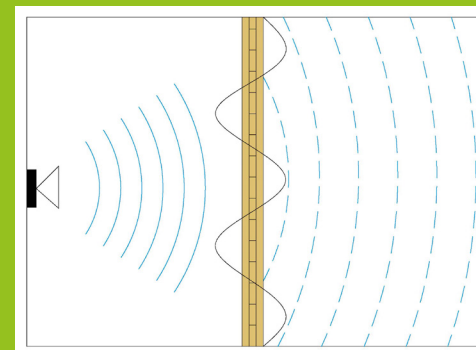

Airborne sound

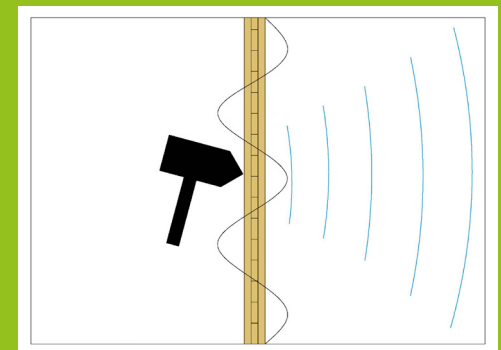

Structure-borne sound

Descriptors and requirements in European countries

Single-number values from EN ISO 717: 2013			
	Airborne sound	Impact sound	
Soundproofing of components	R_w	$L_{n,w}$	Shows the test bench situation. Sound transmission through the partition assembly only.
Soundproofing between rooms	R'_w $D_{n,w}$ $D_{nT,w}$	$L'_{n,w}$ $L_{nT,w}$	Shows the building site situation. Sound transmission through the separating component and flanking components.

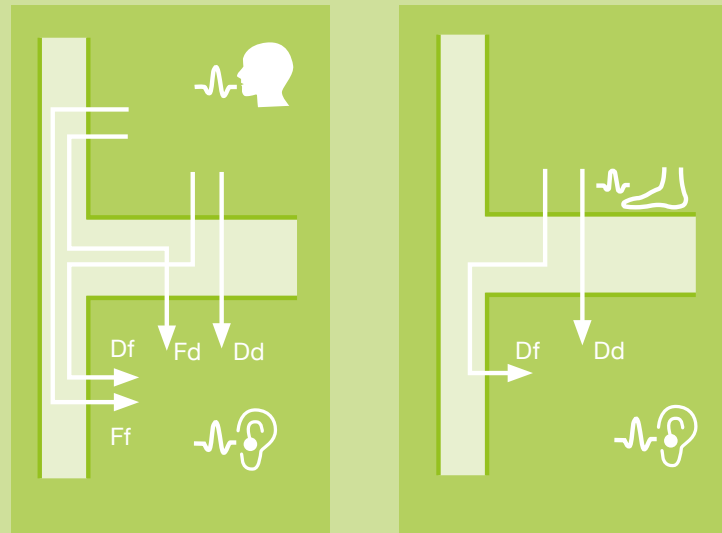

Sound transmission pathways between two rooms

F ... Flanking transmission (indirect)
 D... Direct transmission
 f flanking radiation (indirect)
 d ... direct radiation

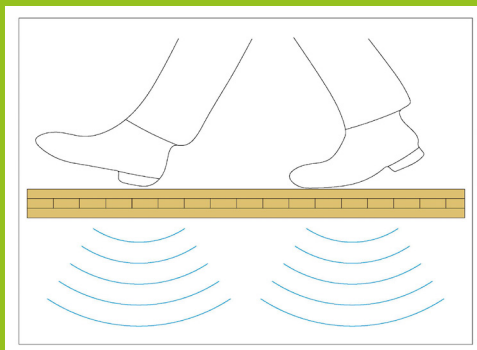

Impact sound

Mass formula for CLT by Stora Enso

For a first estimation, the sound reduction index of a CLT element can be calculated from its mass. The mass of the plate is calculated from thickness and its density in kg/m^2 and is the basis for the equations of the weighted sound reduction index R_w of the CLT plate. Measurements have shown, that the installation angle has an impact on R_w , so two equations have been developed (one for walls and one for floors), taking the usual thickness of the particular application into account.

“Mass laws for CLT” is derived from mean values of available measurement results, excluding peculiar outliers. Results are given

in separate equations for CLT walls and CLT floors with the respective thicknesses mentioned, for which the equation can be applied to.

$$R_{w,CLT,wall} = 25 \lg m'_{CLT} - 8 \text{ in dB}$$

applicable for CLT Walls from 60 to 150 mm

$$R_{w,CLT,floor} = 12,2 \lg m'_{CLT} + 15 \text{ in dB}$$

applicable for CLT Floors from 120 to 320 mm

Sound insulation of CLT components

Ceiling structures

The sound insulation of ceiling structures can be improved either by increasing the mass or by improving the acoustic isolation of components. Adding mass by ballasting a raw ceiling or suspended ceiling reduces vibrations, causing less noise emissions. Above their resonance frequency, the transmission of component vibrations within the structure is reduced. Therefore, the resonance should be as low in frequency as possible (< 80 Hz).

In practice, this means installing relatively heavy screed — 5–7 cm cement screed (note: the edge insulation strip

is not cropped until the flooring has been laid) — on a soft impact sound insulation board ($s' \leq 10$)¹⁾ with backfill or bulk to provide additional mass underneath. In the case of non-suspended ceilings, the thickness of the bulk must be increased to approx. 10 cm and, due to its high sound attenuation capacity, the bulk should preferably be bonded. In terms of sound insulation, ceiling linings are most effective when decoupled (mounted on spring clips or hoops). Cavities should be insulated with mineral wool to prevent cavity resonance.

¹⁾ s' = dynamic stiffness (MN/m³)

Wall panels

The sound insulation of single-layer building components is defined by their surface-based mass and flexural rigidity. According to Berger's mass law, doubling the mass increases sound insulation by 6 dB, and thereby proportionally increases the efficiency of the sound insulation. The critical coincidence frequency is the weak point of the sound insulation. For multi-layer panels with facing, greater sound insulation can be achieved with less mass.

In such mass-spring systems, below the resonance frequency f_0 , the sound insulation increases at a rate of 6 dB per octave, however, above f_0 , it increases by 18 dB per octave. To achieve good sound insulation, the resonance must be as low in frequency as possible (≤ 100 Hz). Resonance frequency can be reduced by increasing the gaps between layers, increasing the mass and ensuring that insulating panels are attached as flexibly as possible to the load-bearing wall. To avoid cavity resonance, the insulating panels should be filled with sound-absorbing insulation material.

Ceiling structures

Noise levels from laboratory and construction site measurements.

Details about the construction of connection nodes are available on request.

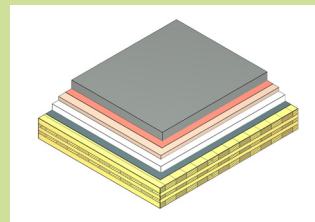

- 70 mm cement screed (2200 kg/m³)
- 0.2 mm PE membrane
- 30 mm soft impact sound insulation ($s' < 10$ MN/m³)
- 100 mm gravel (loose or elastically bound)
- 140 mm CLT by Stora Enso

$R_w(C;C_{tr}) = 63 (-2;-5)$ dB
 $L_{n,w}(C) = 43 (-3)$ dB

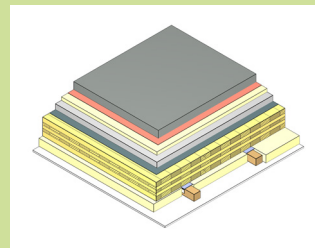

- 70 mm cement screed (2200 kg/m³)
- 0.2 mm PE membrane
- 30 mm soft impact sound insulation ($s' < 10$ MN/m³)
- 50 mm gravel (loose or elastically bound)
- 140 mm CLT by Stora Enso
- 70 mm suspension; 60 mm mineral wool intermediate layer
- 15 mm plasterboard

$R_w(C;C_{tr}) = 63 (-2;-6)$ dB
 $L_{n,w}(C) = 46 (1)$ dB

External walls

Noise levels from laboratory and construction site measurements.

Details about the construction of connection nodes are available on request.

$D_{nT,w}(C;C_{tr})$: 67 (-1;-4) dB

Double-layer facing panel

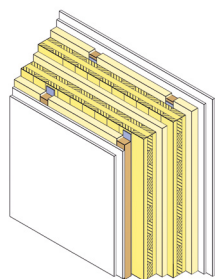

- 12.5 mm plasterboard
- 12.5 mm plasterboard
- 50 mm separate facing panel (CW-profile including 50 mm mineral wool)
- 5 mm glazing gasket
- 100 mm Stora Enso CLT
- 40 mm mineral wool
- 100 mm Stora Enso CLT
- 5 mm glazing gasket
- 50 mm separate facing panel including 50 mm mineral wool
- 12.5 mm plasterboard
- 12.5 mm plasterboard

$D_{nT,w}(C;C_{tr})$: 60 (-2;-8) dB

Single-layer facing panel

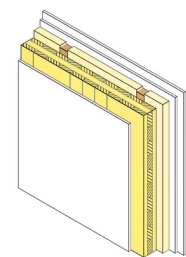

- 12.5 mm plasterboard
- 100 mm Stora Enso CLT
- 5 mm glazing gasket
- 50 mm separate facing panel (CW-profile including 50 mm mineral wool)
- 12.5 mm plasterboard
- 12.5 mm plasterboard

$D_{nT,w}(C;C_{tr})$: 61 (-3;-10) dB

Double-layer visible CLT panel

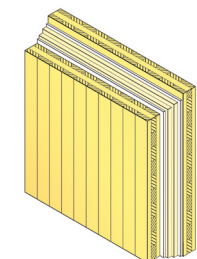

- 100 mm Stora Enso CLT
- 12.5 mm plasterboard
- 30 mm mineral wool
- 30 mm mineral wool
- 5 mm layer of air
- 100 mm Stora Enso CLT

Prediction model for airborne sound insulation of CLT-Walls with ETICS

Described prediction model for R_w is based on a semiempirical approach with a limited amount of reliable measurements. Thus, it should be improved and extended by adding additional measurements and refining the equation. Nevertheless, accuracy of the model, considering a standard deviation σ of 1,6 and maximum deviations of +2,0 and -2,6 dB, seem to be within common precision of building acoustical applications.

Please note that the use of material data from literature can lead to an over- or underestimation of the sound insulation because especially the dynamic stiffness of insulation materials can vary significantly also within one type of material. Therefore, always measured data, or data provided from the producer should be used for the calculation.

Thermal insulation system and CLT visible surface

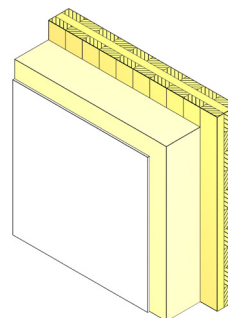

- 7 mm plaster system
- 140-220 mm var. insulation
- 100 mm CLT by Stora Enso

Insulation material	dynamic stiffness s'	Sound reduction index $R_w(C, C_{tr})$
Hemp Fibre	3 MN/m ³	51 (-3, -10) dB
Mineral Wool	5 MN/m ³	44 (-2, -8) dB
Polystyrene	6 MN/m ³	43 (-5, -10) dB

The resonant frequency f_R is calculated, taking the two masses of CLT and the plaster as well as the spring (defined by s') of the insulation material into account.

$$f_R = \frac{1}{2\pi} \sqrt{s' * \left(\frac{1}{m'_{CLT}} + \frac{1}{m'_{putz}} \right)} \text{ in Hz}$$

Based on f_R , the R_w of the wall is calculated according to the following equation:

$$R_w = -30 \lg f_R + 110 \text{ in dB}$$

Internal walls

Noise levels from laboratory and construction site measurements. Details about the construction of connection nodes are available on request.

Even if there are no specific soundproofing requirements for individual rooms within an apartment, sound insulation should still be borne in mind when planning buildings to provide protection against noise. Improvements to the soundproofing of internal walls, such as mounting facing panels, should be made in noisy areas as this helps to reduce the transmission of sound into the structure and lowers the proportion of flanking sound.

The sound insulation of a 100 mm-thick CLT wall with different types of cladding was tested in a series of measurements in the laboratory for building physics at the Technical University of Graz.

CLT non-faced wall

$R_w / C; C_{tr}$: 34 (-1;-3) dB

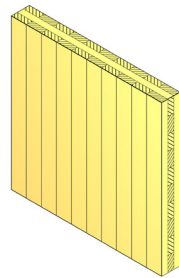

100 mm CLT by Stora Enso

Fire protection plaster board on one side

$R_w / C; C_{tr}$: 37 (-1;-3) dBI

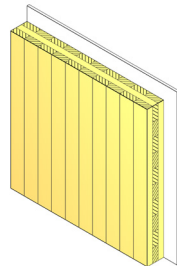

100 mm Stora Enso CLT
12.5 mm fire-protection plasterboard

Fire protection plaster board on both sides

$R_w / C; C_{tr}$: 37 (-1;-3) dB

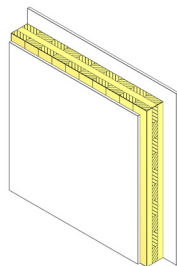

12.5 mm fire-protection plasterboard
100 mm Stora Enso CLT
12.5 mm fire-protection plasterboard

Spring clip

$R_w / C; C_{tr}$: 48 (-5;-12) dB

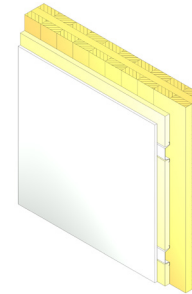

100 mm CLT by Stora Enso
27 mm spring clip
12.5 mm fire-protection plasterboard

Spring hoop

$R_w / C; C_{tr}$: 51 (-2;-8) dB

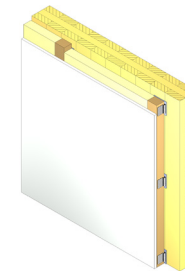

100 mm Stora Enso CLT
3 mm joint sealing tape
50 mm spring clip with an intermediate layer of mineral wool
12.5 mm fire-protection plasterboard

Wooden battens

$R_w / C; C_{tr}$: 45 (-1;-5) dB

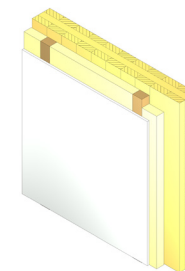

100 mm Stora Enso CLT
50 mm wooden batten (intermediate layer of mineral wool)
12.5 mm fire protection plasterboard

More information about Soundproofing with CLT:

- storaenso.com
- dataholz.com
- ligumdata.ch

CLT and fire protection

CLT exposed to fire

Stora Enso CLT has a moisture content of approx. 12%. If CLT is exposed to fire and thus to an elevated supply of energy, its temperature rises and the water molecules embedded within start to evaporate at approx. 100 °C. At 200–300 °C, these chemical compounds decompose in a process known as “pyrolysis” (whereby gas emissions from combustible components in the wood burst into flame), gradually spreading along the wood, leaving a charring area behind. This char layer is formed from the carbonaceous residue of pyrolysis, which burns, generating embers. This layer’s properties — in particular, low density and high permeability — act as heat insulation and protect the underlying, undamaged wood.

This produces the protective effect of the char layer on the internal CLT layers which have not yet been affected by fire, so that — unlike steel or concrete constructions — although the solid wood constructions become charred on the surface, the pyrolysis process and the behaviour of wood when exposed to fire can actually be predicted.

Unlike steel constructions, for example, which require additional fire protection measures, wood is already naturally protected by properties such as pyrolysis and the ability to form a char layer. Wood is a truly ecological building material and demonstrates unique behaviour when exposed to fire, thus giving CLT building elements their excellent fire resistance.

To support this statement, Stora Enso asked an accredited institute to test the fire resistance of CLT. The results speak for themselves, demonstrating the high level of fire resistance of CLT components.



Cross-section surface of a char layer of an 80 mm-thick CLT element, originally clad with fire protection plasterboard, after a large-scale fire test: It is easy to identify the different layers on this cross section: the charred area (black area), followed by the pyrolysis area (brown area) — caused by the spreading fire or pyrolysis — and the undamaged wood.

The fire behaviour of Stora Enso CLT is classified as D-s2, d0

The verification of the fire resistance of timber components can either be based on classification reports in accordance with EN 13501-2 on the basis of large-scale fire tests, or on calculations according to EN 1995-1-2, performed in conjunction with the respective national application documents.

CLT external wall structures

Internal cladding	Service cavity	Cross-laminated timber element		External cladding	Test load	Classification i↔o
		Designation	Lamella structure [mm]		[kN/m]	
12.5 mm fire protection plasterboard	—	CLT 100 C3s	30–40–30	50 mm wood wool slab, 15 mm plaster	35	REI 90
12.5 mm fire protection plasterboard	—	CLT 100 C3s	30–40–30	80 mm rock fibre, 4 mm plaster	35	REI 90
12.5 mm fire protection plasterboard	—	CLT 100 C5s	20–20–20–20–20	50 mm wood wool slab, 15 mm plaster	35	REI 90
12.5 mm fire protection plasterboard	—	CLT 100 C5s	20–20–20–20–20	80 mm rock fibre, 4 mm plaster	35	REI 90
12.5 mm fire protection plasterboard	40 mm mineral wool	CLT 100 C3s	30–40–30	50 mm wood wool slab, 15 mm plaster	35	REI 90
12.5 mm fire protection plasterboard	40 mm mineral wool	CLT 100 C3s	30–40–30	80 mm rock fibre, 4 mm plaster	35	REI 90

CLT wall structures

Cladding	Service cavity	Cross-laminated timber element		Test load	Classification i↔o
		Designation	Lamella structure [mm]	[kN/m]	
—	—	CLT 100 C3s	30–40–30	35	REI 60
—	—	CLT 100 C5s	20–20–20–20–20	35	REI 60
12.5 mm fire protection plasterboard	—	CLT 100 C3s	30–40–30	35	REI 90
12.5 mm fire protection plasterboard	—	CLT 100 C5s	20–20–20–20–20	35	REI 90
12.5 mm fire protection plasterboard	40 mm mineral wool	CLT 100 C3s	30–40–30	35	REI 90
35 mm ProCrea clay panel, 5 mm ProCrea clay undercoat plaster with reinforcement fabric, 5 mm ProCrea clay finishing plaster	—	CLT 140 C5s	40–20–20–20–40	280	REI 90
12.5 mm fire protection plasterboard	40 mm mineral wool	CLT 100 C3s	30–40–30	35	REI 120

Classifications of the tested components

CLT ceiling structures

Cladding	Suspended ceiling	Cross-laminated timber element		Test load	Classification I↔O
		Designation	Lamella structure [mm]	[kN/m ²]	
12.5 mm fire protection plasterboard (on the unexposed side) or floor structure	—	CLT 100 L3s	30–40–30	0.6	REI 60
—	—	CLT 140 L5s	40–20–20–20–40	5	REI 60
—	—	CLT 160 L5s	40–20–40–20–40	6	REI 90
12.5 mm fire protection plasterboard	—	CLT 140 L5s	40–20–20–20–40	5	REI 90
35 mm Heraklith EPV	—	CLT 140 L5s	40–20–20–20–40	5	REI 90
12.5 mm fire protection plasterboard	40 mm mineral wool	CLT 140 L5s	40–20–20–20–40	5	REI 90

Classifications of the tested components

Verification of the fire resistance of CLT elements based on calculations according to EN 1995-1-2:2011 (Eurocode 5)

Determining the load-bearing capacity (R) of CLT elements according to EN 1995-1-2:2011

When determining the load-bearing capacity (R) of timber components exposed to fire, or when calculating cross-sectional values, in addition to determining the charring area, the underlying area affected by temperature must also be taken into account because the strength and stiffness properties of wood decrease as the temperature rises.

As an alternative to the calculation option specified in EN 1995-1-2, annex B, the cross-sectional values can also be calculated using two simplified methods. We recommend the first method:

- reduced cross-section method
- reduced properties method

Determining the integrity (E) and insulation (I) of CLT elements

The following options exist for verification of integrity (E) and insulation (I):

- Calculation method according to EN 1995-1-2:2011, annex E
- Model according to ÖNORM B 1995-1-2:2011, 14.3 or in the European technical guideline entitled “Fire safety in timber buildings” or the thesis by Vanessa Schleifer entitled “Zum Verhalten von raumabschließenden mehrschichtigen Holzbauteilen im Brandfall” (Performance of separating multiple layer timber elements in the event of fire; 2009)
- Structures according to ÖNORM B 1995-1-2:2011 are possible without further analysis.

can be performed using the model specified in ÖNORM B 1995-1-2:2011 or in the European technical guideline entitled “Fire safety in timber buildings” which have the same approach or support the same theory.

If we compare this model with the calculation method specified in EN 1995-1-2:2011, annex E, in the first one, the possibility of an unlimited variation of materials and number of layers can be considered a significant advantage.

Verification of the integrity and insulation of CLT elements



4. Structural analysis

General information

Designing and sizing CLT structures

Structural analysis

The special feature when analysing and designing CLT is that the transverse layers have a low rigidity in shear. As a result, the deflection caused by shear can no longer be ignored. Various analysis methods have been developed, to reflect this behavior. These methods are outlined briefly below, and the publications containing full details are listed. Cross-laminated timber cannot be regarded and treated in the same way as solid timber or glulam.

Analysis using laminate theory

With the aid of “panel design factors”

This analysis method does not account for deflection from shear and therefore only applies to relatively large span/thickness ratios (approx. > 30). For symmetrical panel designs, equations for calculating the effective flexural rigidity E_{eff} in panels and discs are specified in the CLT technical folder.

With the aid of the “shear correction coefficient”

Applying the appropriate corrective shear coefficient in the analysis of the shear rigidity of a CLT section, returns the shear deformation of a CLT panel (e.g.: floor or roof). This deflection needs to be added to the elastic deflection, based on the Euler Bernoulli theory. This assembly of theories is also called the Timoschenko beam theory. State of the art software for structural engineering is able to include shear deformations in the design.

As the board layers are bonded at right angles to each other, the load is transferred along two main axes — also known as biaxial load bearing. In the past, this was the preserve of reinforced concrete structures. The advantage of this is a more flexible plan layout; designs can also be simplified, and lower floor to floor heights are possible. Although diagonally-projecting or point-

supported structures require more planning effort, they are perfectly feasible.

CLT panels have a particularly high load bearing capacity as point loads are generally spread across the entire panel width due to the cross layers. The high rigidity of CLT is very beneficial for the bracing of a building.

Analysis using the γ -method

This method was developed to analyze flexibly connected beam sections and can also be applied to CLT. It is sufficiently precise for common building dimensions and is described for use with cross-laminated timber. This method is also mentioned in various timber design standards, e.g. in DIN 1052-1:1988, DIN 1052:2008, ÖNORM B 4100-2:2003 and EN 1995-1-1 (Eurocode 5).

Analysis using the shear analogy method

The shear analogy method is described in DIN 1052-1:2008 annex D and is known as a precise method for calculating cross-laminated timber with any type of layer structures. However, the application is not practical and requires ideally engineering software.

2D shell analysis of CLT

Analysis using beam grid models

CLT panels for floors and roofs, following a more complex shape in plan, can be modelled, using 2D frame programs or FEM software. In this case, the representative beams in X direction have a flexural rigidity of CLT along its X axis and vice versa for the Y direction.

Analysis using FEM software

Almost any CLT structure can be designed, using FEM software. If the software includes a laminate or CLT design module, the design becomes more user friendly.

Connector design in CLT

General rules from EN 1995-1-1 apply to CLT as well as for glulam or solid timber. More detailed information can be found in the technical assessment documents of the respective connector manufacturer.

Designing CLT using Stora Enso's engineering software

Stora Enso offers Calculatis, a timber design tool, free of charge at calculatis.storaenso.com. It can be used to analyze common building components from CLT and other timber products.

The following CLT elements can be calculated using this software:

- floors or roofs
- rib panels
- shear walls
- deep beams
- headers above windows and doors
- 2-way cantilever panels
- supports
- load distribution on shear walls
- connectors
- timber concrete composite panels
- basics in building physics

Preliminary design tables

The design tables are intended as an assistance in the preliminary design but cannot replace a full structural design.

Permanent load (g _p)	Snow load s _s	Span CLT panel (single span)										
		3.00 m	3.50 m	4.00 m	4.50 m	5.00 m	5.50 m	6.00 m	6.50 m	7.00 m		
1.00	1.00	80 L3s	90 L3s	90 L3s	120 L3s	120 L3s	140 L5s	140 L5s	160 L5s	160 L5s	180 L5s	200 L5s
	2.00	100 L3s		140 L5s		180 L5s		200 L5s				
	2.80	90 L3s	100 L3s	120 L3s	140 L5s	160 L5s	180 L5s	200 L5s	220 L7s-2	240 L7s-2		
	3.50										120 L3s	140 L5s
	4.00	100 L3s	120 L3s	140 L5s	160 L5s	180 L5s	200 L5s	220 L7s-2	240 L7s-2			
	5.00									140 L5s	160 L5s	180 L5s
1.50	1.00	90 L3s	90 L3s	120 L3s	140 L5s	160 L5s	180 L5s	200 L5s	220 L7s-2	240 L7s-2		
	2.00		100 L3s								140 L5s	160 L5s
	2.80	90 L3s	100 L3s	120 L3s	140 L5s	160 L5s	180 L5s	200 L5s	220 L7s-2	240 L7s-2		
	3.50										120 L3s	140 L5s
	4.00	100 L3s	120 L3s	140 L5s	160 L5s	180 L5s	200 L5s	220 L7s-2	240 L7s-2			
	5.00									140 L5s	160 L5s	180 L5s
2.00	1.00	90 L3s	100 L3s	120 L3s	140 L5s	160 L5s	180 L5s	200 L5s	220 L7s-2	240 L7s-2		
	2.00		120 L3s								140 L5s	160 L5s
	2.80	90 L3s	100 L3s	120 L3s	140 L5s	160 L5s	180 L5s	200 L5s	220 L7s-2	240 L7s-2		
	3.50										120 L3s	140 L5s
	4.00	100 L3s	120 L3s	140 L5s	160 L5s	180 L5s	200 L5s	220 L7s-2	240 L7s-2			
	5.00									140 L5s	160 L5s	180 L5s
2.50	1.00	90 L3s	100 L3s	120 L3s	140 L5s	160 L5s	180 L5s	200 L5s	220 L7s-2	240 L7s-2		
	2.00		120 L3s								140 L5s	160 L5s
	2.80	90 L3s	100 L3s	120 L3s	140 L5s	160 L5s	180 L5s	200 L5s	220 L7s-2	240 L7s-2		
	3.50										120 L3s	140 L5s
	4.00	100 L3s	120 L3s	140 L5s	160 L5s	180 L5s	200 L5s	220 L7s-2	240 L7s-2			
	5.00									140 L5s	160 L5s	180 L5s

Single-span beam: deformation

Ultimate limit state:
Flexural stress design
Shear stress design

$$k_{\text{mod}} = 0.9$$

Serviceability:
Initial deflection
 $w_{\text{inst}} < L/300$
Net final deflection
 $w_{\text{net fin}} < L/250$

$$k_{\text{def}} = 0.8$$

* The CLT self-weight is already taken into account in the table with $\rho = 500 \text{ kg/m}^3$.

Service class 1, imposed load

Snow load ($\psi_0 = 0.5$; $\psi_1 = 0.2$; $\psi_2 = 0.0$)

In accordance with ETA-14/0349 (03.06.2019)
EN 1995-1-1 (2014)
EN 1995-1-1: 2015 NA Austria

R0	
R30	Fire resistance: HFA 2011
R60	$\beta_{0,h} = 0,65 \text{ mm/min}$ $\beta_{1,h} = 1,30 \text{ mm/min}$

Permanent load (g _k)	Live load q _k	Span of single-span beam								
		3.00 m	3.50 m	4.00 m	4.50 m	5.00 m	5.50 m	6.00 m	6.50 m	7.00 m
1.00	1.00									
	2.00									
	2.80	120 L3s	120 L3s	140 L5s	160 L5s	160 L5s	180 L5s	220 L7s-2	240 L7s-2	260 L7s-2
	3.50									
	4.00									
1.50	5.00						200 L5s			
	1.00									
	2.00									
	2.80	120 L3s	120 L3s	140 L5s	160 L5s	180 L5s	200 L5s	220 L7s-2	240 L7s-2	260 L7s-2
	3.50									
2.00	4.00									
	5.00									
	1.00									
	2.00									
	2.80	120 L3s	120 L3s	140 L5s	160 L5s	180 L5s	220 L7s-2	240 L7s-2	260 L7s-2	280 L7s-2
2.50	3.50									
	4.00									
	5.00									
	1.00									
	2.00									
2.50	2.80	120 L3s	120 L3s	140 L5s	160 L5s	200 L5s	220 L7s-2	240 L7s-2	260 L7s-2	280 L7s-2
	3.50									
	4.00									
	5.00									

Single-span beam: vibration

Ultimate limit state:

- Flexural stress design
- Shear stress design

$$k_{\text{mod}} = 0.8$$

Serviceability:

- Initial deflection
 $w_{\text{inst}} < L/300$
- Net final deflection
 $w_{\text{net, fin}} < L/250$
- Vibration
According to
ÖNORM B 1995-1-1:2014
Floor class I
 $\zeta = 4\%$, 5 cm cement
screed ($E = 26,000 \text{ N/mm}^2$), $b = 1.2 \cdot \ell$

$$k_{\text{def}} = 0.8$$

- * The CLT self-weight is already taken into account in the table with $\rho = 500 \text{ kg/m}^3$.

Service class 1, imposed load category A ($\psi_0 = 0.7$; $\psi_1 = 0.5$; $\psi_2 = 0.3$)

In accordance with ETA-14/0349 (02.10.2014)
EN 1995-1-1 (2014)

R0
R30
R60

Fire resistance:
HFA 2011



5. Project management

Project phases

Quotation phase

We will be happy to draw up an appropriate quotation for you based on your documents. The main elements of a quote are as follows:

- quantities (net area, gross area, area required to perform the saw pattern or for cutting waste)
- panel design
- quality
- machining
- transport costs
- additional products or services

Sending us precise information and documents will enable us to provide an accurate quote. Good quality planning documents will also help to speed up the quoting process. Additional information concerning the most common file formats used can be found below:

- Specifications and tender texts: in general, we strongly recommend including the gross areas. The additional area required for cutting waste will basically depend on the building's geometry, and therefore on the derived CLT components.

Charged dimensions

Example: 15,900 × 2,950 mm

Charged dimensions: 2.95 × 15.90	46.91 m ²
Area of panel (net):	38.59 m ²
Cutting waste:	8.32 m ²
Charged dimensions:	46.91 m ²

Charged lengths	8.00 m to 16.00 m (in 10 cm increments)
Charged widths	2.45 m, 2.75 m, 2.95 m

- Plans submitted to building authorities: these plans will enable us to create at least one 3D model without details (openings or machining elements) so that we can rapidly calculate the dimensions. If possible, please always send us plans submitted to building authorities in DWG or DXF file format. PDF files are generally poor quality and require more time to process.
- 3D models: in the majority of cases, more or less detailed 3D data is already available. This enables lists of materials (XLS or CSV files) to be drawn up quickly. However, if we still need 3D formats to prepare the quote, we will ask you to send us corresponding 3D-DWG, 3D-DXF, SAT (ACIS) and/or IFC files which it should be possible to generate with most CAD programs.

Ideally, we would prefer to receive implementation plans in 2D or 3D file format and which are as detailed as possible already during the quotation phase. This will help reduce any differences in terms of quantities and cost between the quote and the final contract.

A preliminary design plan which enables easy dimensioning of the required panel thicknesses is available for downloading free-of-charge from storaenso.com/woodproducts/clt. If you require our assistance with the preliminary design, please provide us with the following information:

- imposed load
- constant loads
- snow load

Order phase

If Stora Enso submits a quotation for your project, we would be grateful if you would sign and return it to us as confirmation that you wish to place the order with us. A corresponding production capacity will be immediately reserved based on the quantity available and the required delivery date. The definitive planning documents or project dates must be sent to us 20 working days prior

to the shipment date (date on which the truck leaves our factory). Otherwise, the delivery date will be automatically postponed by at least a week.

To enable rapid processing of your order, please indicate the following information clearly on your 2D and/or 3D planning documents:

- component geometry
- component name
- grain direction of cover layers
- panel thickness
- panel design
- surface quality
- list of components with columns for: component name, number of items, type of panel (e.g. L3S), quality (e.g. INV), thickness, length, width, net area, net volume

A CLT order form is available for downloading on our website storaenso.com/woodproducts/clt. You are also welcome to use your own form as long as the required information is clearly indicated and easy to understand. A corresponding email form can also be used. For first-time orders, we recommend that you contact us approx. four to five weeks prior to the delivery date to set up or test the exchange of CAD data, in order to avoid unnecessary delays when confirming and processing orders. We work with AutoCAD Architecture and hsbCAD. Our preferred data formats are DWG, DXF, SAT-V7.0 and IFC.

Once the required project documents have been received, the Stora Enso CLT engineering team will commence the definitive planning of your project. Depending on the time requirements, we will send you the corresponding inspection documents which you must check and approve.

After approval, Stora Enso will start production of your CLT project. Please note that, in principle, any requests for changes will only be taken into account if they are received before the final 12 working days before the shipping date.

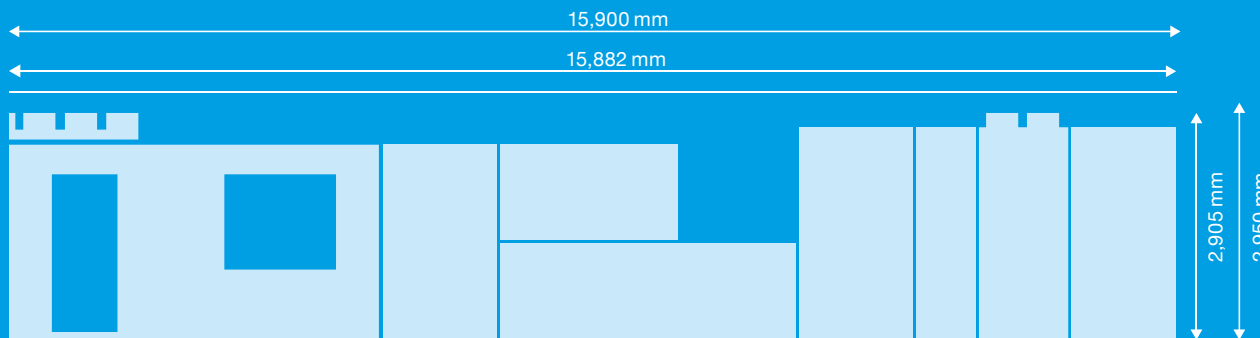

Shipping

Horizontal transport

A standard articulated trailer can be loaded up to a maximum of 25 t in the case of horizontal transport, with a maximum load length of 13.60 m and a maximum load width of 2.95 m. If the panel thickness permits, CLT solid wood panels with a maximum length of 15.00 m can also be transported with a standard articulated trailer. A density of 490 kg/m³ can be applied to calculate the load weight. As a general rule, a standard shipping quantity is approx. 50 m³. The maximum authorised loading height is 2.60 m for a standard articulated trailer.

If any special equipment is required, we will be happy to provide you with a suitable quotation. However, please note the following changes to the max. load length, width and weight:

We wrap the panels in foil (visible quality elements are wrapped in UV impermeable foil) and cover them with a truck tarpaulin. This is necessary to protect the panels against ambient influences. We then place the panels between lashing straps and cardboard edge protectors to further protect them.

We use a minimum of 8 wooden skids (105 × 105 mm or 95 × 95 mm) as standard under the first layer of panels loaded onto the trailer. The wooden skids are equipped with non-slip pads. After that, however, every subsequent layer is stacked horizontally directly on top of the previous one.

Please inform us when placing the order (and include diagrams) if you require intermediate wooden skids for unloading by crane or forklift. The wooden skids will be retained by the haulage company. If you keep the skids for your own use, we will charge them to your account.

Standard equipment	Max. load	Max. load length	Max. load width
Standard articulated trailer	25 t	15.00 m	2.95 m
Special equipment	Max. load	Max. load length	Max. load width
Extendable trailer	24 t	16.00 m	2.95 m
Steerable trailer	20 t	15.00 m	2.95 m
Steerable trailer with all-wheel drive	on request	on request	

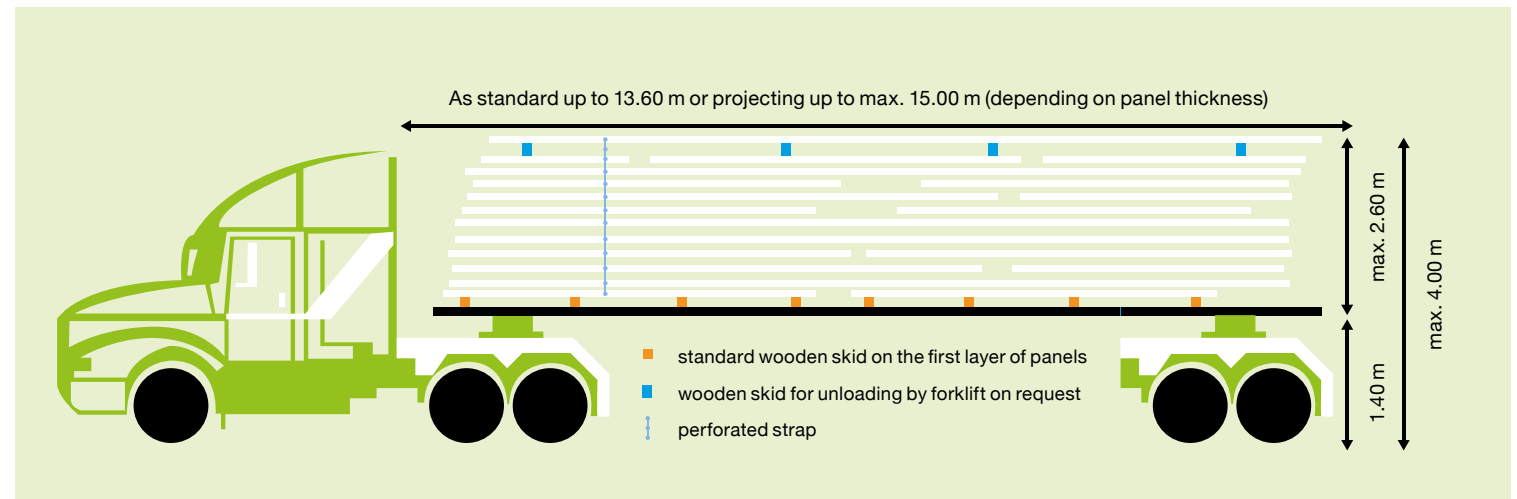

Vertical transport

A mega trailer can be loaded to a maximum of 24 t in the case of vertical transport, with a max. load length of 13.50 m and a max. load height of 2.95 m. Please note that, as a result of the A-shaped frames, the total load capacity is lower than with horizontal transport (max. approx. 45 m³, depending on the panel edge dimensions and thicknesses).

A density of 470 kg/m³ can be applied to calculate the load weight. Each trailer has at least 6 A-shaped frames against which the CLT solid wood panels can be leaned and then screwed to each other (screw points are marked in colour). The panels are then further connected to each other using lashing straps on the sides of the racks, and the entire load is then also firmly strapped together. The panels are also placed on chocks which prevent them from slipping or tilting. As with horizontal transport, cardboard edge protectors are placed between the lashing straps and the panels.

If visible quality panels are to be loaded vertically, they will be fastened on the narrow sides with perforated straps to prevent damage. If the A-shaped frames or chocks are not returned to us, we will charge them to your account.

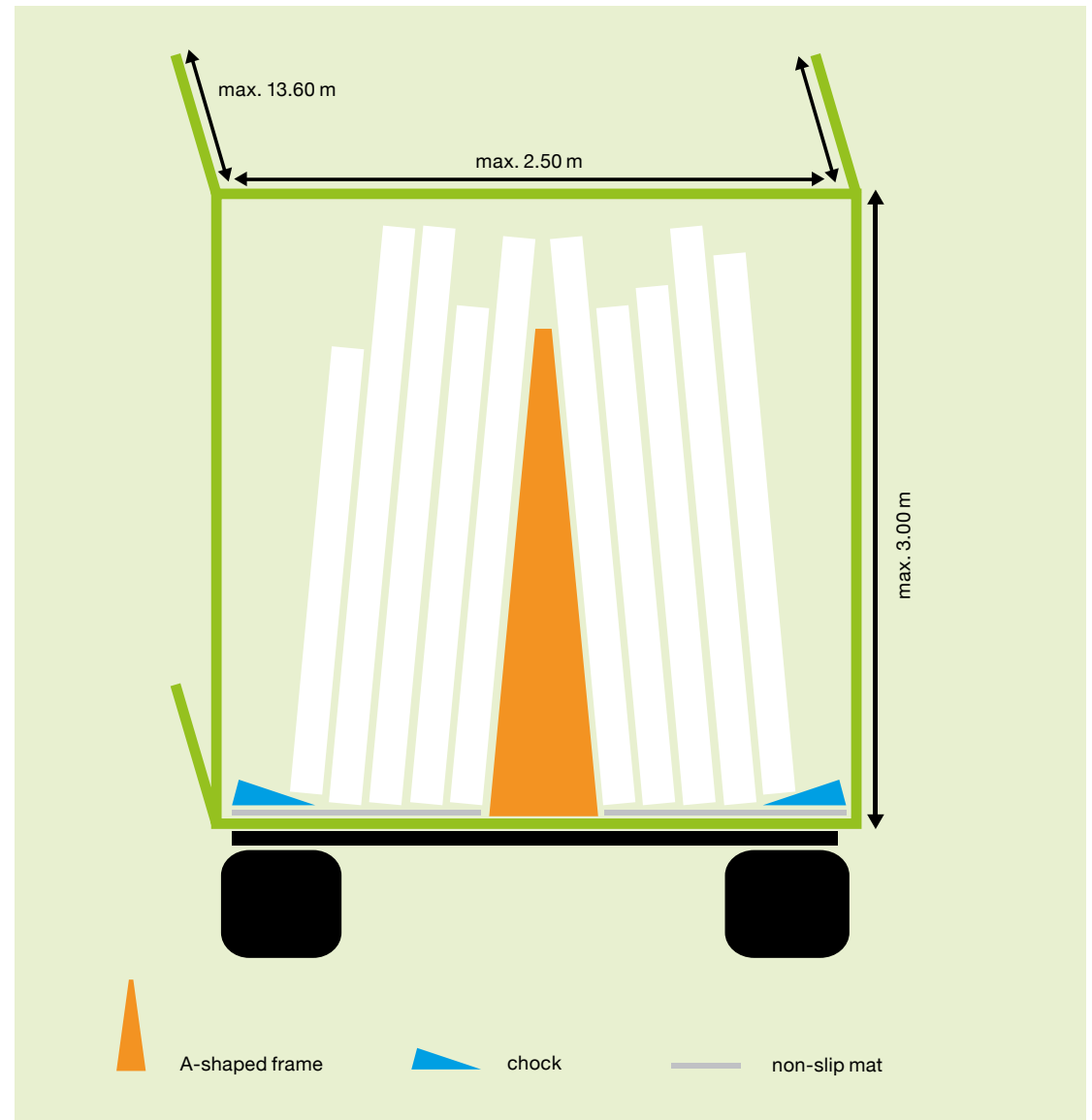



Publisher, responsible for the contents:
Stora Enso Wood Products GmbH.
Printed on Stora Enso MultiArt Silk paper.
Subject to typographical or printing errors.

Stora Enso Division Wood Products

Business Line CLT

storaenso.com/woodproducts/clt
facebook.com/storaensolivingroom

THE RENEWABLE MATERIALS COMPANY